

DENISON HYDRAULICS

Proportional Directional Valves Cetop 08

Series 4DP06-E/H

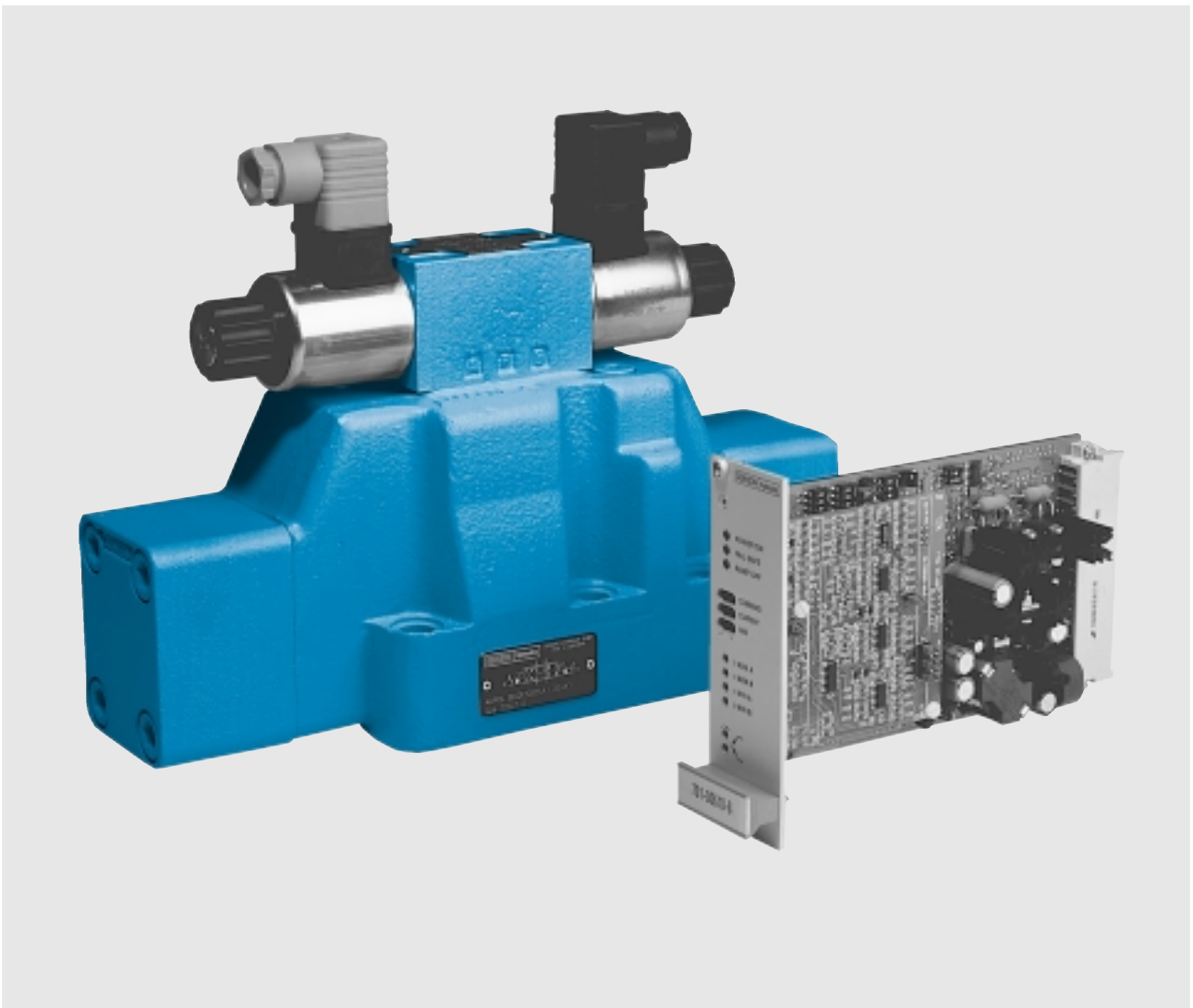

Publ. 4-EN 3800-C (dig.)

DENISON Hydraulics

FEATURES, SYMBOL

FEATURES

- Optimized machine cycle times through stepless motion control.
- Spools for a variety of functions.
- Simple design and insensitivity to contamination result in problem free operation.
- Suitable for externally closed loop control systems.
- Increased system efficiency.
- One source supply of valve and proportional amplifier ensures optimized performance.
- Standard electrical connection according to ISO 4400.
- Mounting configuration conform to ISO 4401.
- Stackable 2- and 3-port pressure compensators maintain flow independent of load induced pressure changes. Available in two different pressure drop ranges (see pages 9...12).
- No dynamically loaded seals.
- Each valve is factory tested prior to delivery.
- Field interchangeable spools and tightest tolerances.
- Worldwide DENISON service and support.

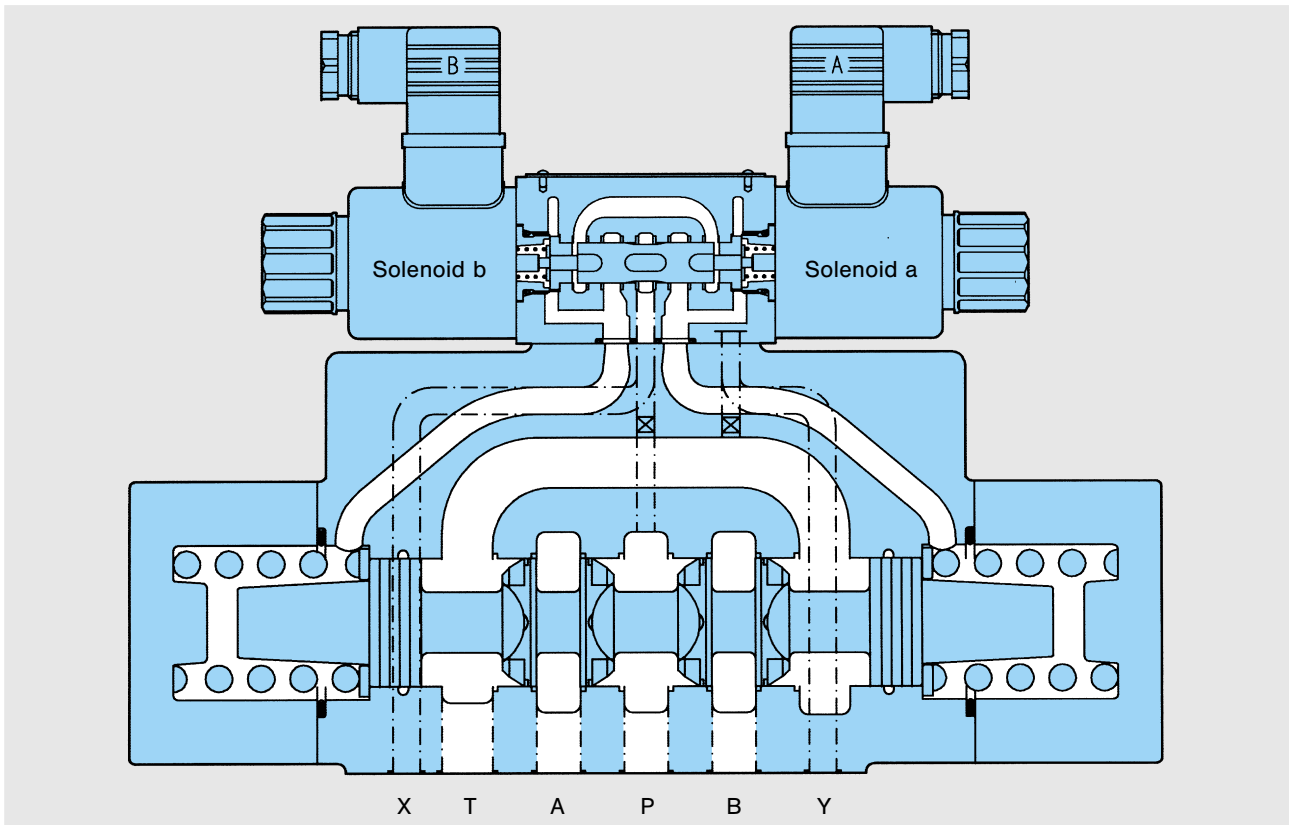

SYMBOL

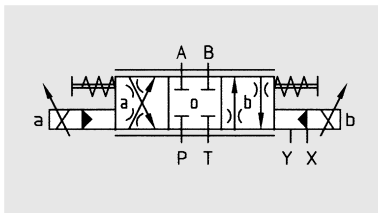

Example:
2-solenoid version 4DP06 3E

DESCRIPTION

GENERAL

This type of pilot operated proportional directional valve is used where large flows are controlled by electronic signals.

The pilot stage as proportional pressure reducing valve works on the principle of barometric feedback. The main stage with ISO 4401 mounting pattern consists of the main spool with control notches and two heavy springs for centring and force balance positioning.

ELECTRO-HYDRAULIC PILOT VALVE

The 3-way proportional reducing pilot stage controls the main valve. The special pilot spool features the force balanced function of the pilot valve. The pilot pressure at the P-port of the pilot valve must not exceed 105 bar. At higher pressures a 2-way pressure reducing module (option R1) is required.

HYDRAULIC OPERATION

The main valve of the hydraulic operated version (option H) must be controlled by an external proportional pilot valve (e. g. 4RP01). In this case a control cover is mounted on top of the main valve. The valve is piloted through ports X or Y of the main valve mounting surface. The pilot valve should be installed maximum 1 m from the main stage.

ELECTRONIC

The electronic developed in conjunction with the valve are illustrated in this brochure, with schematic block diagrams and terminal connections, as well as accessories.

OPERATION

An electrical input signal (command) at the pilot stage results in a precise hydraulic output signal to the main spool. The position of the main spool is fed back to the pilot spool assembly "barometrically" (means by pressure).

The position of the main spool is reached if the pilot pressure of one main-control chamber is in balance with the feedback pressure generated by the powerful spool spring of each side of the main spool assembly.

In neutral position the control edges of the main spool overlaps the body lands by 15 % of the stroke. The notches of the main spool (DENISON type "F") are designed to achieve a smooth opening characteristic after they leave this mechanical spool overlap. Their specific profile allows a smooth control of low flow at command signals up to 50 %.

For the control of differential cylinders with a common area of 2 : 1 the largest spool size is available for 50 % ratio (1/2 Q) of the return flow.

Please see also under "Ordering Code" on page 5.

FAIL SAFE

The powerful main springs return the main spool to the centre position when the electrical signal of the electro-proportional pilot stage is removed.

PRESSURE COMPENSATORS

The flow of a proportional valve equates to $Q = f(\Delta p : A)$, the pressure differential Δp across the throttling orifice A.

Pressure compensators sense the input and output pressure of the proportional valve and maintain a constant pressure differential (Δp).

In combination with 2- or 3-port pressure compensators, proportional valves maintain flow or speed independent of load pressure.

TECHNICAL DATA

GENERAL AND HYDRAULIC CHARACTERISTICS

<ul style="list-style-type: none"> • Design • Mechanical overlap • Effective overlap / command • Mounting position • Type of mounting • Pilot pressure in X <ul style="list-style-type: none"> – without option R1 – with option R1 • Max. operating pressure <ul style="list-style-type: none"> – at internal drain – at external drain • Flow • Nominal flow • Maximum flow recommended • Fluid temperature range • Ambient temperature range • Viscosity range • Hysteresis • Repeatability • Response time <ul style="list-style-type: none"> – step signal 0...100% – step signal 100...0% – step signal + 100...-100% • Fluid • Contamination level 	<p>Sliding spool valve, proportional controlled without feedback transducer</p> <p>≈ 15 %</p> <p>30 %</p> <p>Optional but horizontal recommended</p> <p>Subplate body according to ISO 4401</p> <p>min. T + 35 bar</p> <p>max. 105 bar</p> <p>At > 105 bar only with stack reducing valve, option R1. Factory setting 50 bar.</p> <p>min. T + 45 bar</p> <p>max. 350 bar</p> <table border="0" style="width: 100%;"> <tr> <td style="width: 33%;">P, A, B</td> <td style="width: 33%;">T</td> <td style="width: 33%;">Y</td> </tr> <tr> <td>350 bar</td> <td>15 bar</td> <td>15 bar</td> </tr> <tr> <td>350 bar</td> <td>350 bar</td> <td>15 bar</td> </tr> </table> <p>see curves on page 6</p> <p>200 / 250 / 400 l/min</p> <p>(at Δ p = 5 bar each spool edge)</p> <p>700 l/min (at double path application)</p> <p>– 18...+80 °C</p> <p>– 10...+50 °C</p> <p>10...650 cSt; optimal 30 cSt</p> <p>≤ 5 %</p> <p>≤ 3 %</p> <p>at 50 bar pilot pressure and Δ p = 5 bar at each spool edge; 12 Volt solenoid.</p> <p>60 ms</p> <p>70 ms</p> <p>80 ms</p> <p>Petroleum base anti-wear fluids (covered by DENISON HF-0 and HF-2 specification). Such as mineral oil according to DIN 51524/25. Maximum catalogue ratings and performance data are based on operation with these fluids.</p> <p>Fluid must be cleaned before and continuously during operation by filters that maintain a cleanliness level of NAS 1638 Class 8 (Class 9 for 15 micron or smaller). This basically corresponds to ISO 17/14. Better cleanliness levels will significantly extend the life of the components. As contaminant entrainment and contaminant generation may vary with each application, each must be analysed to determine proper filtration to maintain the required cleanliness level.</p>	P, A, B	T	Y	350 bar	15 bar	15 bar	350 bar	350 bar	15 bar
P, A, B	T	Y								
350 bar	15 bar	15 bar								
350 bar	350 bar	15 bar								

ELECTRIC CHARACTERISTICS

<ul style="list-style-type: none"> • Type of voltage (DC) • Coil resistance <ul style="list-style-type: none"> – cold start 20 °C – warm value 50 °C • Nominal current • Max. current • Max. coil temperature (temperature class F) • Type of protection (DIN 40050) • Relative operating period 	<p>12 V</p> <p>3.7 Ω</p> <p>4.51 Ω</p> <p>2.2 A</p> <p>2.5 A</p> <p>+ 155 °C</p> <p>IP 65</p> <p>100 %</p>
--	--

ORDERING CODE

Model Number: 4DP06 3 A

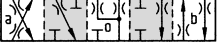
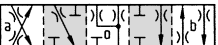
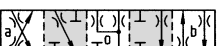
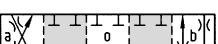
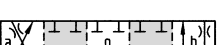
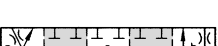
1	Series _____ 06 = Cetop 08	2	Body _____ 3 = Standard	3	Type of Control _____ E = Electro-hydraulic H = Hydraulic	4	Spool Type _____ 02  P→A; B→T or P→B; A→T = Q A2  P→A = 1/2 Q; B→T = Q or P→B = Q; A→T = 1/2 Q B2  P→A = Q; B→T = 1/2 Q or P→B = 1/2 Q; A→T = Q 43  P→A; B→T or P→B; A→T = Q A3  P→A = 1/2 Q; B→T = Q or P→B = Q; A→T = 1/2 Q B3  P→A = Q; B→T = 1/2 Q or P→B = 1/2 Q; A→T = Q	5	Flow P→A; B→T or P→B; A→T _____ F200 = 200 l/min } not available for spools A2, A3, B2 and B3 F250 = 250 l/min } F400 = 400 l/min } (at Δp = 5 bar per spool edge)	6	Spool Position _____ 03 = 3 (a, o, b), spring centred, spool in "o"-position 05 = 2 (o, b), spring centred, spool in "o"-position 06 = 2 (o, a), spring centred, spool in "o"-position	7	Design Letter _____	8	Seal Class _____ 1 = NBR (Buna N) Standard 5 = Viton®	9	Solenoid Voltage _____ G12 = 12 V DC	10	Electrical Connector _____ w/o code = connector not supplied C1 = connector PG 11	11	Main Valve – Pilot Connections _____ w/o code = X, Y external X = internal X, external Y Y = external X, internal Y XY = internal X, internal Y	12	Hydraulic Accessories _____ w/o code = w/o pressure reducing valve (pilot pressure X < 105 bar) R1 = with pressure reducing valve (pilot pressure X > 105 bar)	13	Modifications _____ N0 = without manual override
----------	--------------------------------------	----------	-----------------------------------	----------	--	----------	---	----------	---	----------	--	----------	----------------------------	----------	--	----------	--	-----------	--	-----------	--	-----------	---	-----------	--

CURVES

Step Response Time at pilot pressure 50 bar

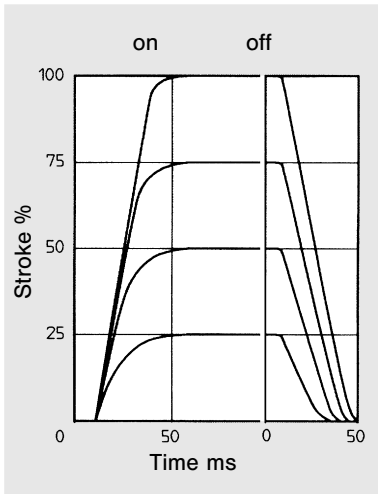

Flow-Command Signal at $\Delta p = 5$ bar each spool edge

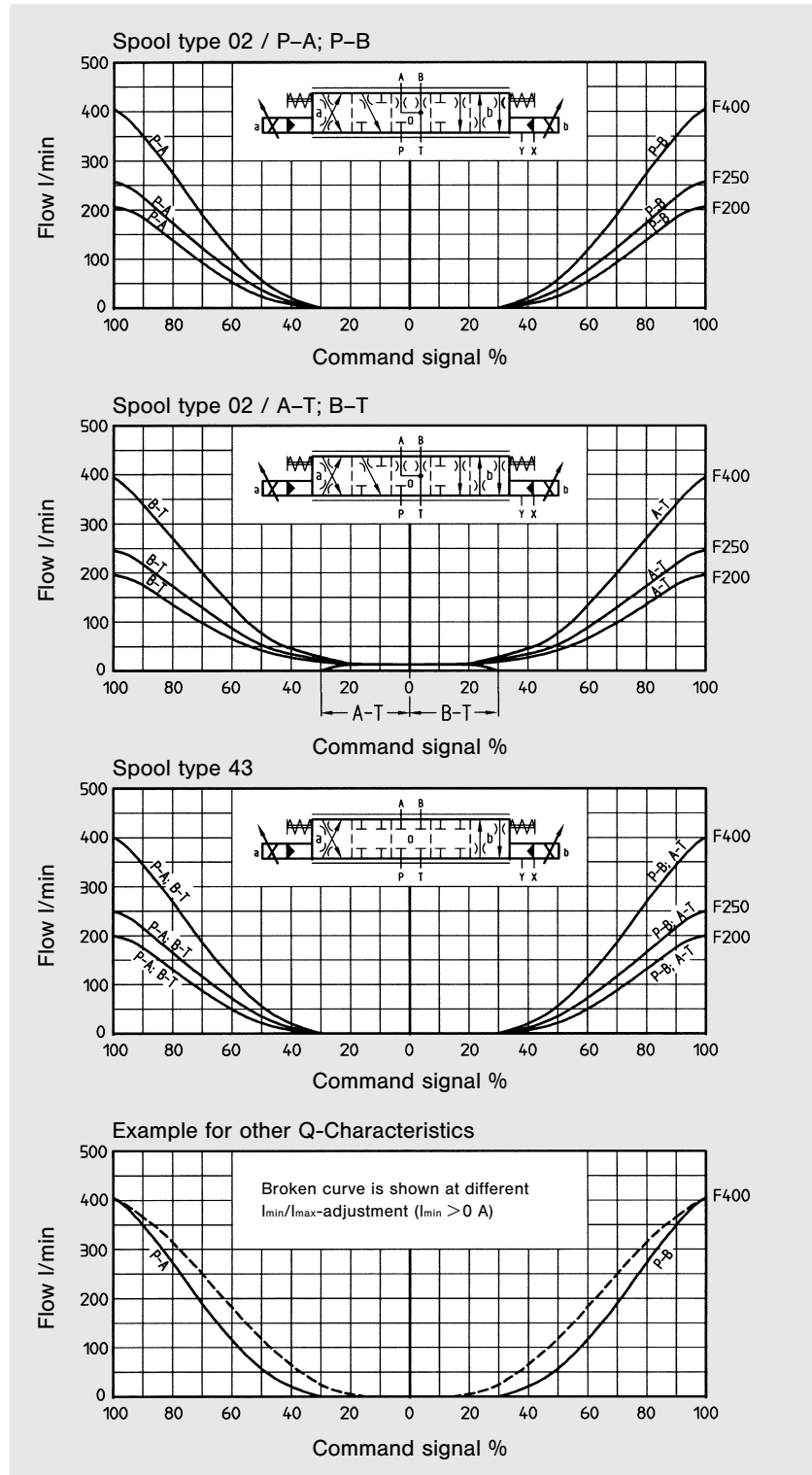

Note: Full line curves are measured with amplifier factory setting:
 $I_{min} = 0$ A, $I_{max} = I_{nom} = 2.2$ A

Nominal flow

Using other pressure drops the flow is changing as following:

$$Q_X = Q_N \cdot \sqrt{\frac{\Delta p_X}{5}}$$

1-1/2-SOLENOID VALVE VERSIONS 4DP06 3E

Weight: 17.6 / 18.1 kg

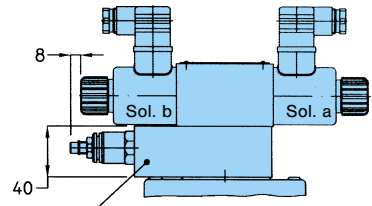
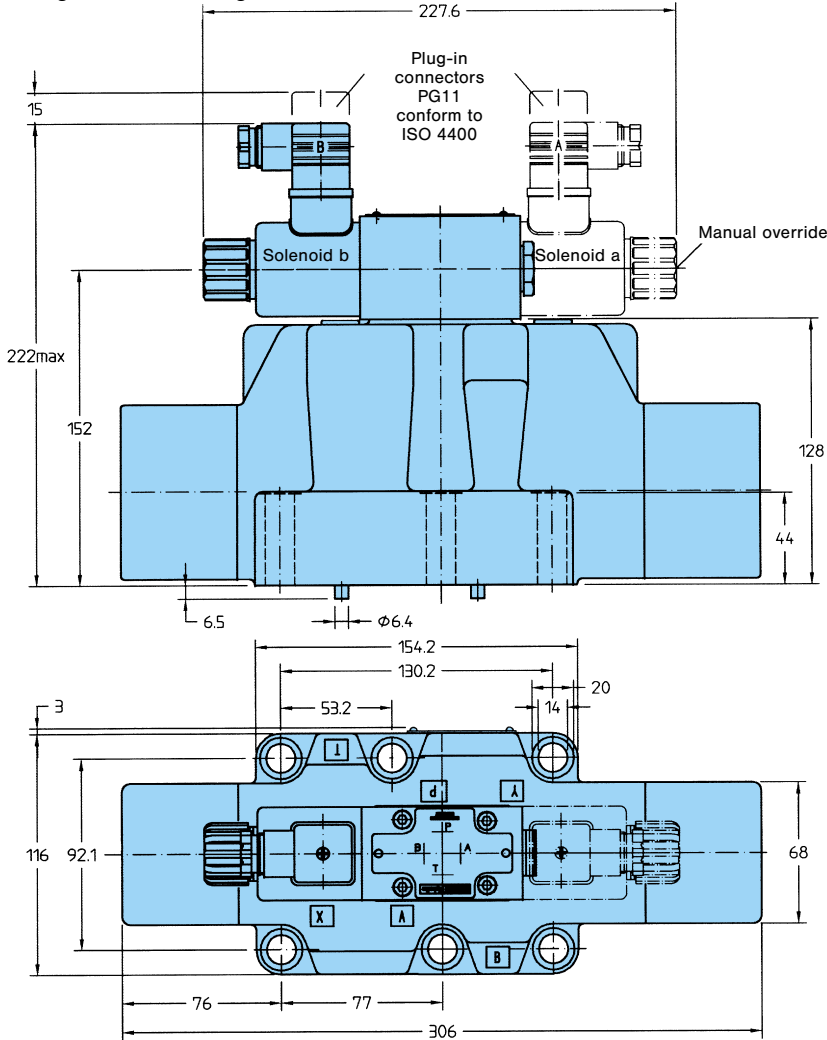

Pressure reducing valve Code R1
(necessary at pilot pressure > 105 bar)
Weight: 1.6 kg

Symbol (detailed)

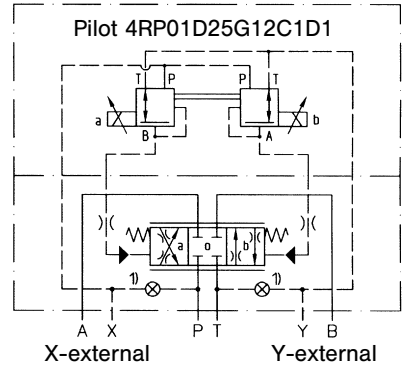

Symbol (detailed)

with pressure reducing valve R1

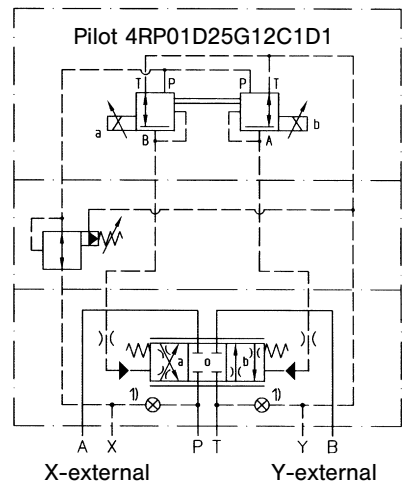

1) Plugs are mounted according to chosen pilot connections.

Electrical connection

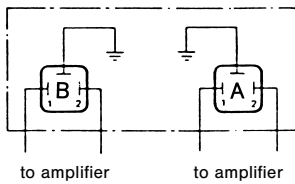

NBR-Seals

A, B, T	28.17 x 3.53	691-00216-0
P	31.34 x 3.53	691-00218-0
X, Y	20.29 x 2.62	691-00117-0

Symbols

Spool position 03

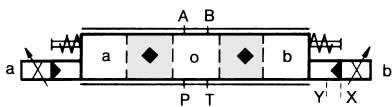

Spool position 05

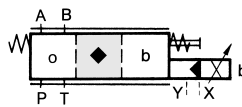

Spool position 06

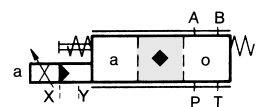

02, A2, B2



02, A2, B2

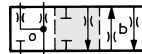

02, A2, B2



43, A3, B3

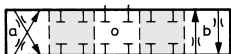

43, A3, B3

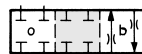

43, A3, B3

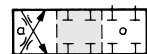

◆ transfer configuration only (not switching position)

HYDRAULIC OPERATION 4DP06 3H

Weight: 16.3 kg

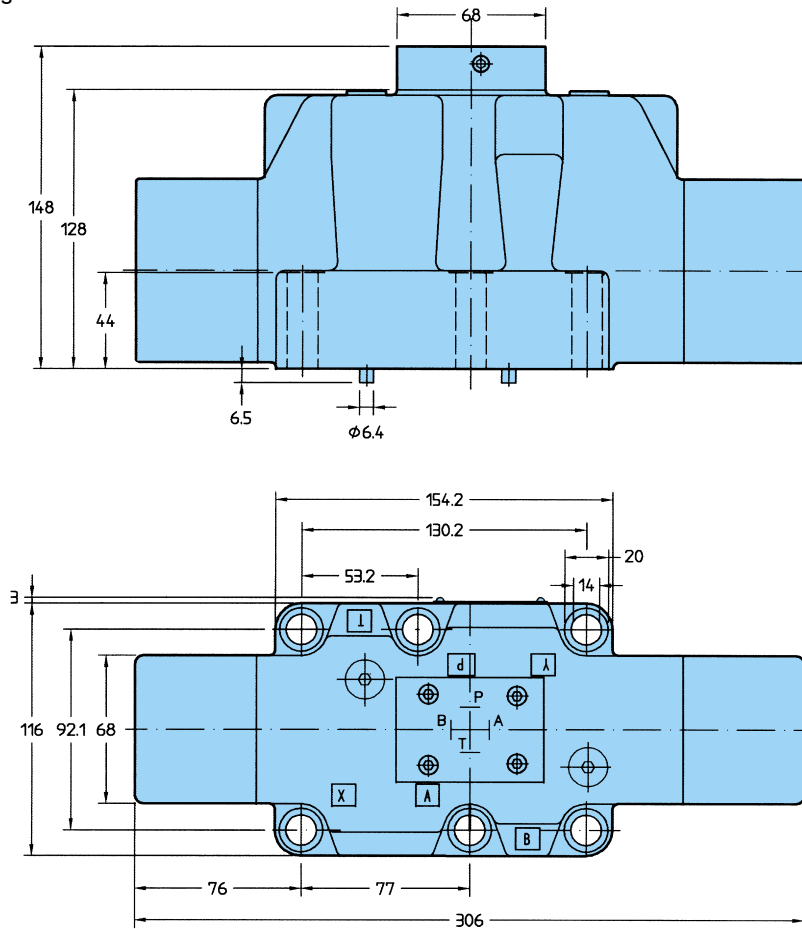

Hydraulic characteristics

Pilot pressure: 0...26 bar

Opening start: 3.5 bar

Pilot volume: 8.5 ml (for switching operation 0...100%)

Seals

A, B, T	28.17 x 3.53	691-00216-0
P	31.34 x 3.53	691-00218-0
X, Y	20.29 x 2.62	691-00117-0

Symbols

Spool position 03

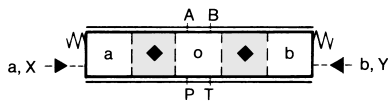

Spool position 05

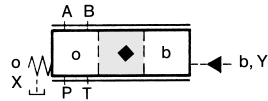

Spool position 06

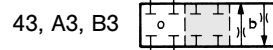
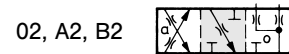
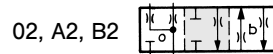
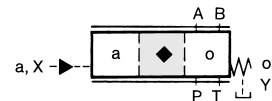

◆ transfer configuration only (not switching position)

PROPORTIONAL VALVE 4DP06 & PRESSURE COMPENSATOR SPC06

FEATURES

- Constant flow control by pressure compensation.
- Two different pressure differences – 5 bar or 10 bar – are available.
- Low mass, fast response time.
- High precision and repeatability by means of pressure compensated pilot flow.
- Pressure compensator can be used in combination with all 4DP06-E/H/T valves.

4DP06

SPC06

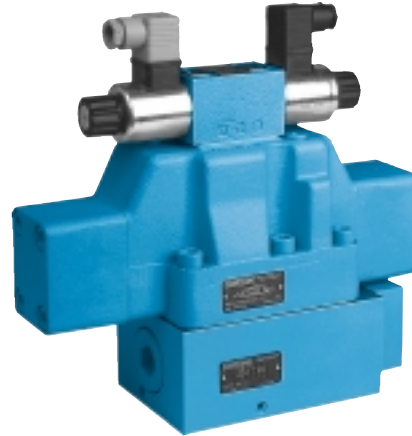

CIRCUIT WITH 2-PORT METER-IN COMPENSATOR (shown with spool 43)

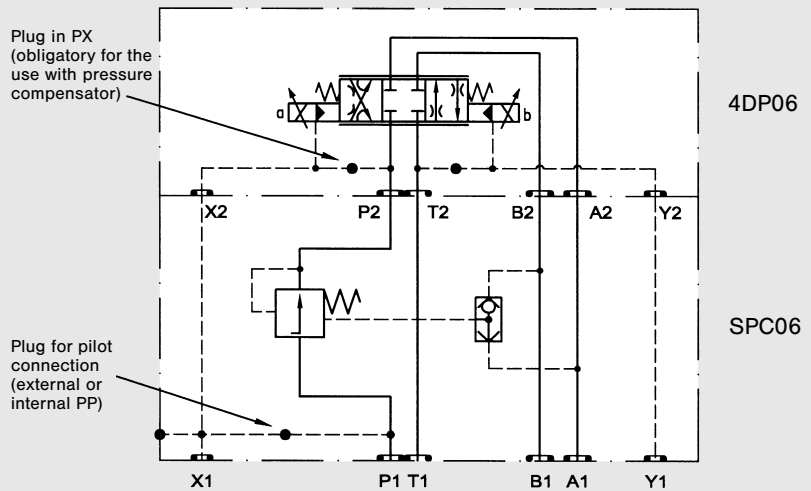

CIRCUIT WITH 3-PORT METER-IN COMPENSATOR (shown with spool 43)

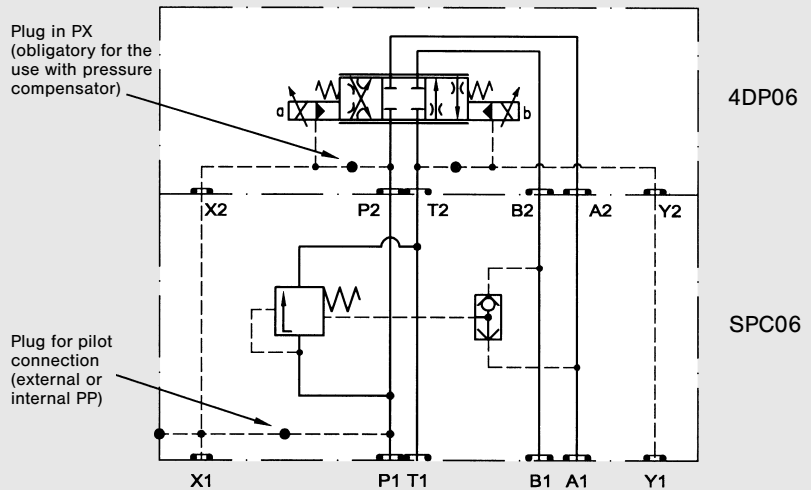

CURVES 4DP06 WITH SPC06

Flow versus System Pressure A, B at $\Delta p = 5$ bar

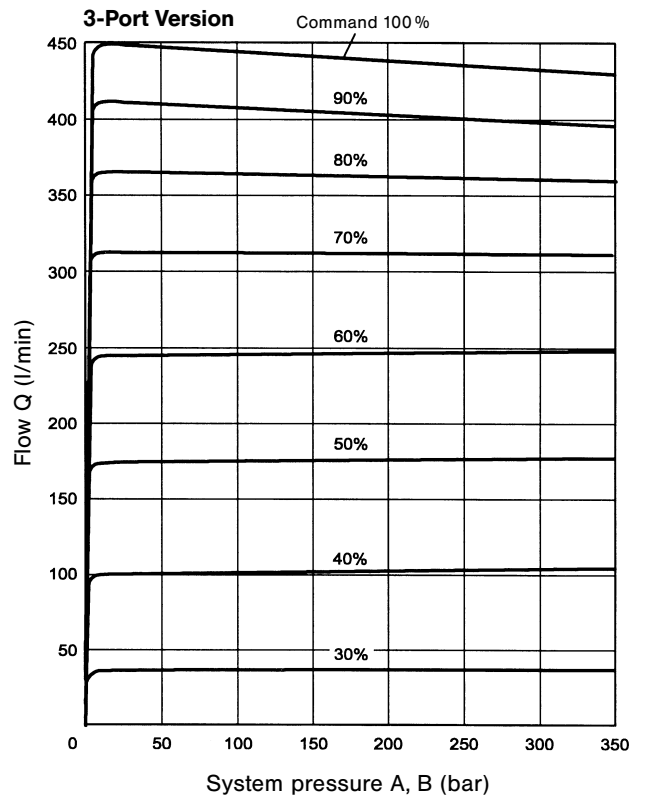
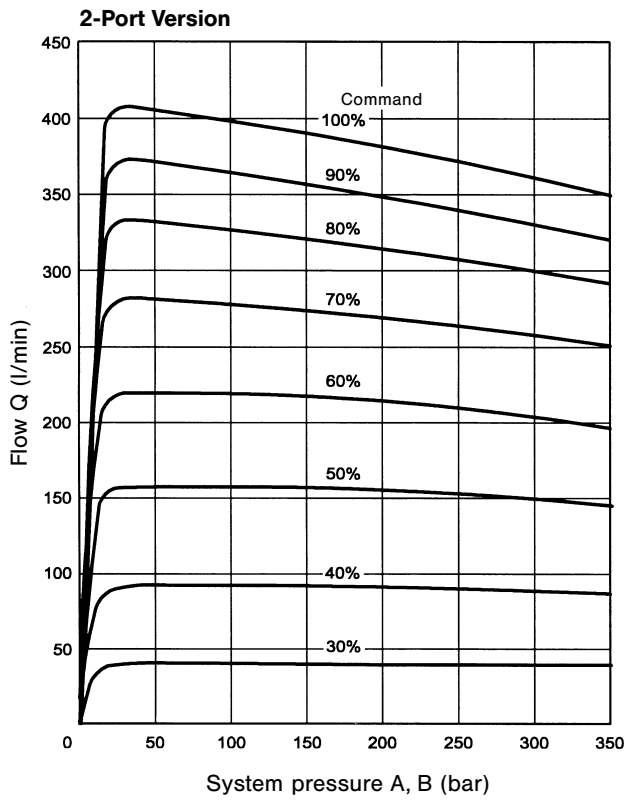

Flow versus System Pressure A, B at $\Delta p = 10$ bar

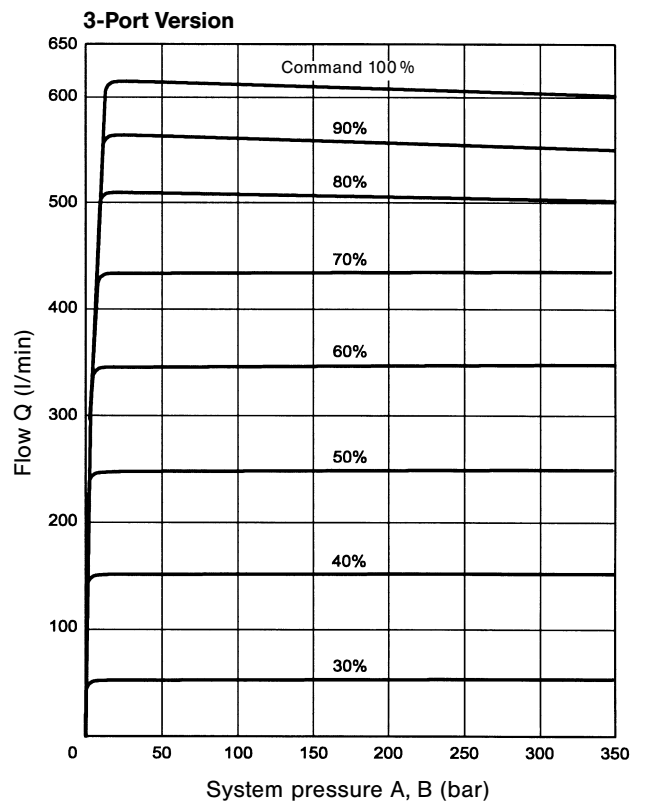
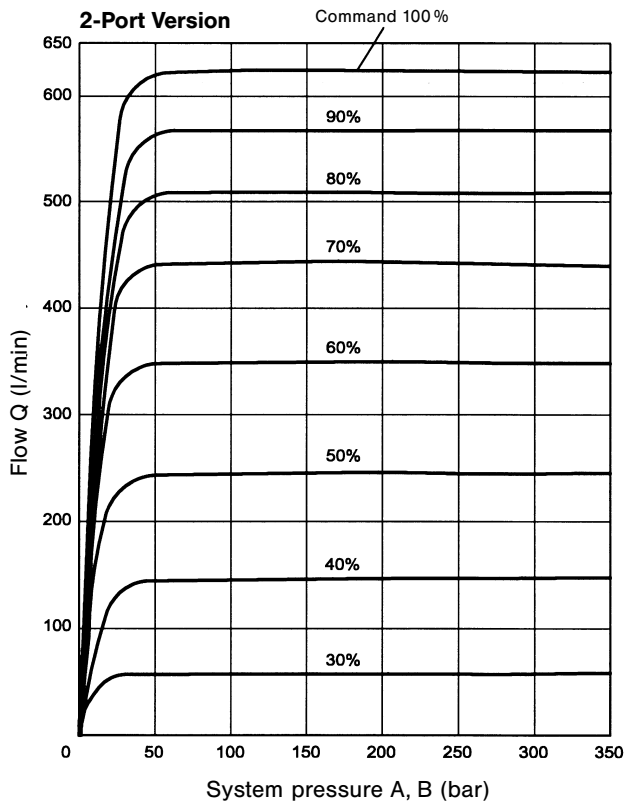

ORDERING CODE SPC06

Model No.:

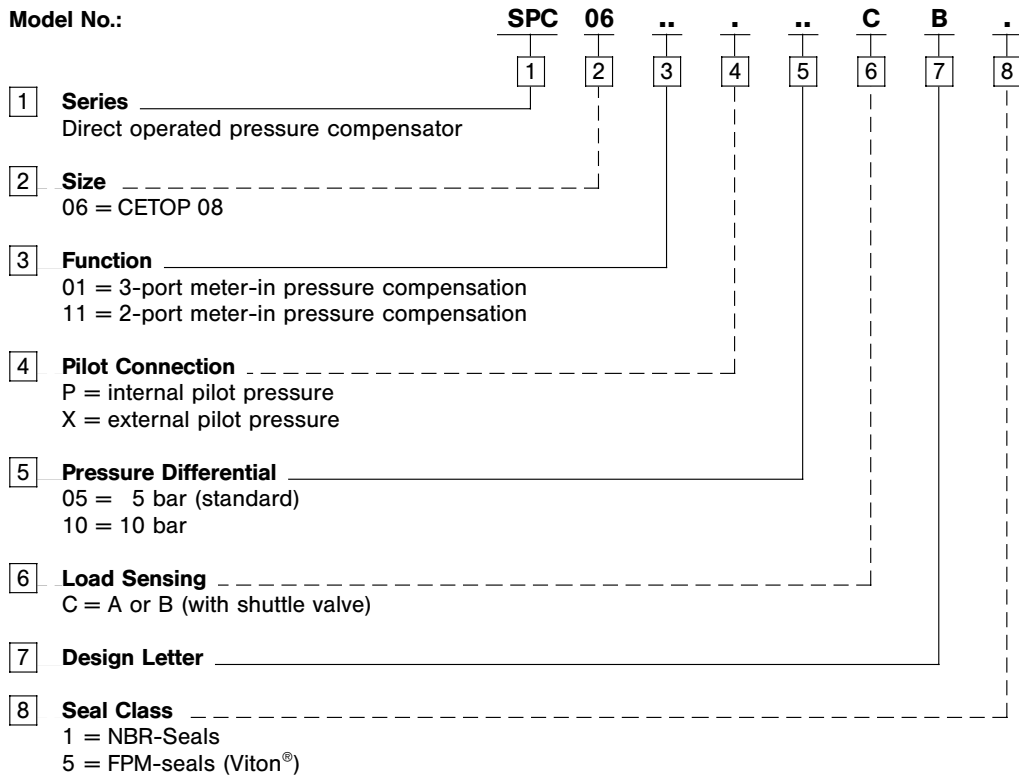

PROPORTIONAL VALVE 4DP06 & COMPENSATOR SPC06

Weight 29.5/30.0 kg (single/double solenoid)

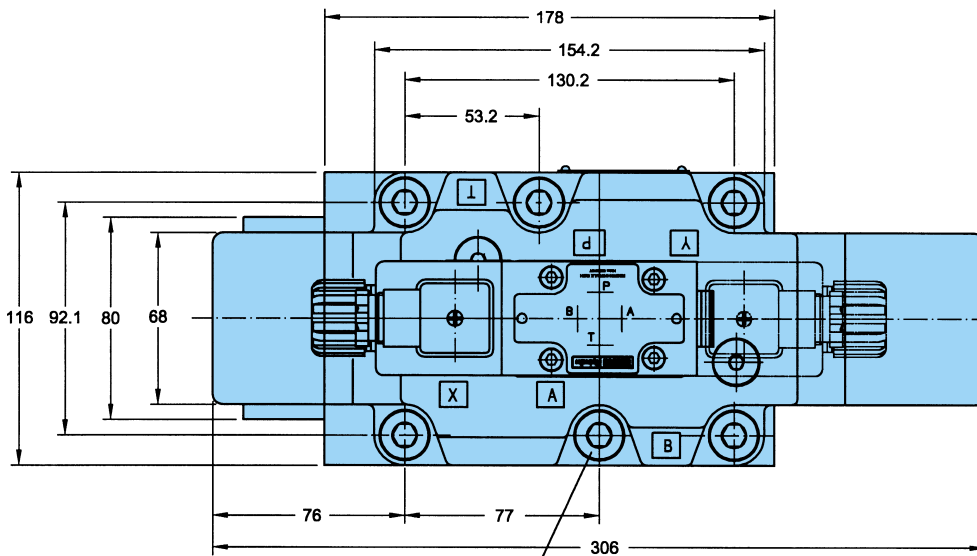
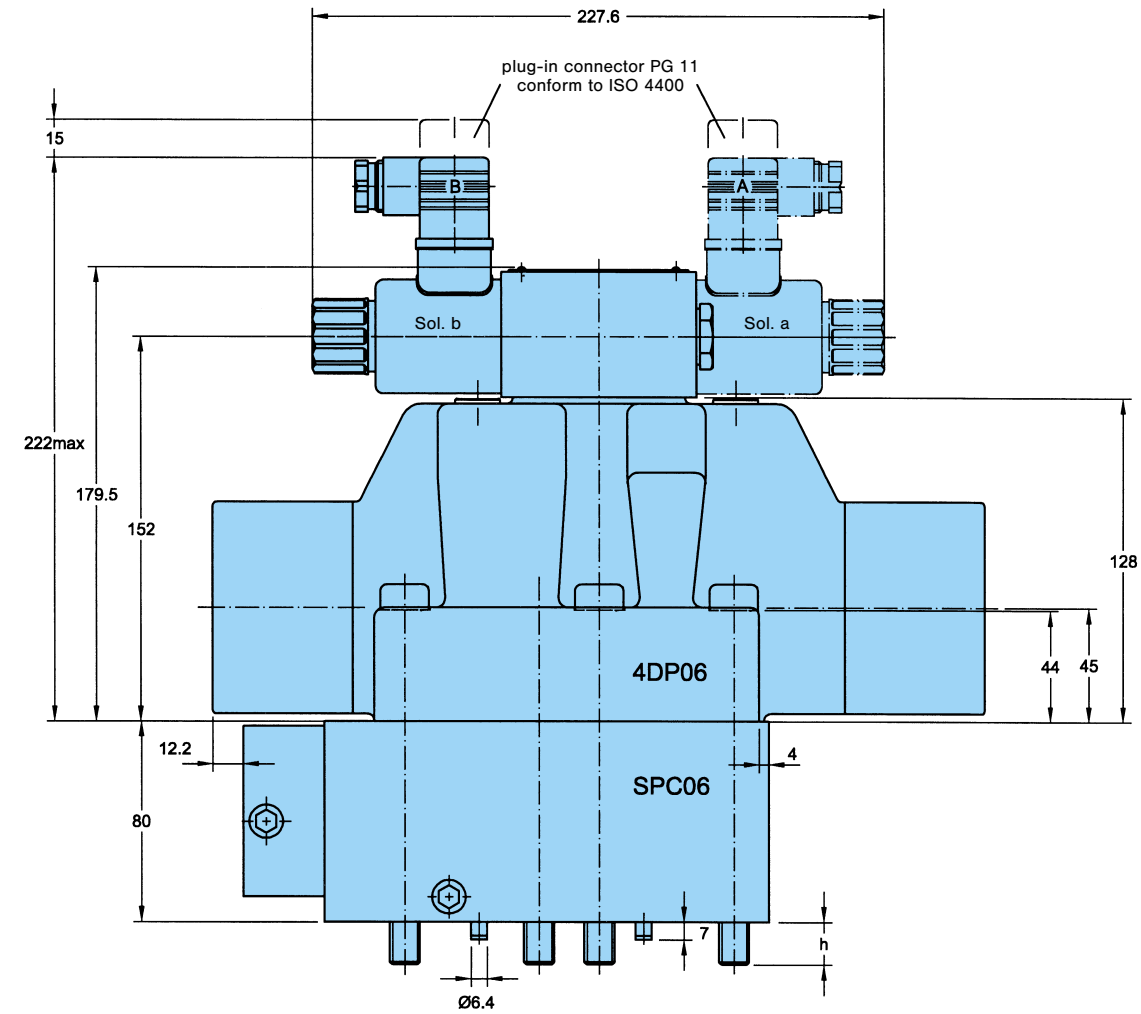

NBR-seals for SPC06

P,A,B,T	28.17 x 3.53	691-00216-0
X,Y	20.29 x 2.62	691-00117-0

6 Screws	Dimensions	Order No.	h
with SPC06	M12 x 140, DIN 912	361-12424-8	16
	1/2"-13 UNC x 5 3/4"	358-20430-8	22

Torque: M12 (1/2") = 103 Nm

MOUNTING CONFIGURATION & SUBPLATE

Mounting Configuration conform to ISO 4401

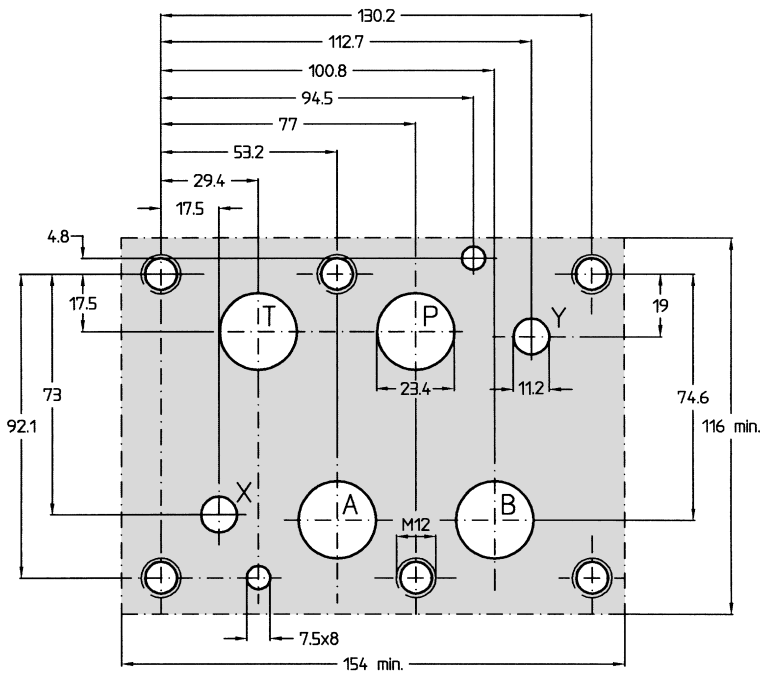

Block mounting face

Flatness 0.01 mm / 100 mm length

Surface finish $\sqrt{0.8}$

Port function

P = Pressure port

A & B = Working ports

T = Tank

X = ext. pilot or ext. drain port

Y = ext. drain or ext. pilot port

Subplate (mount. configuration conform to ISO 4401)

Weight: \approx 8 kg

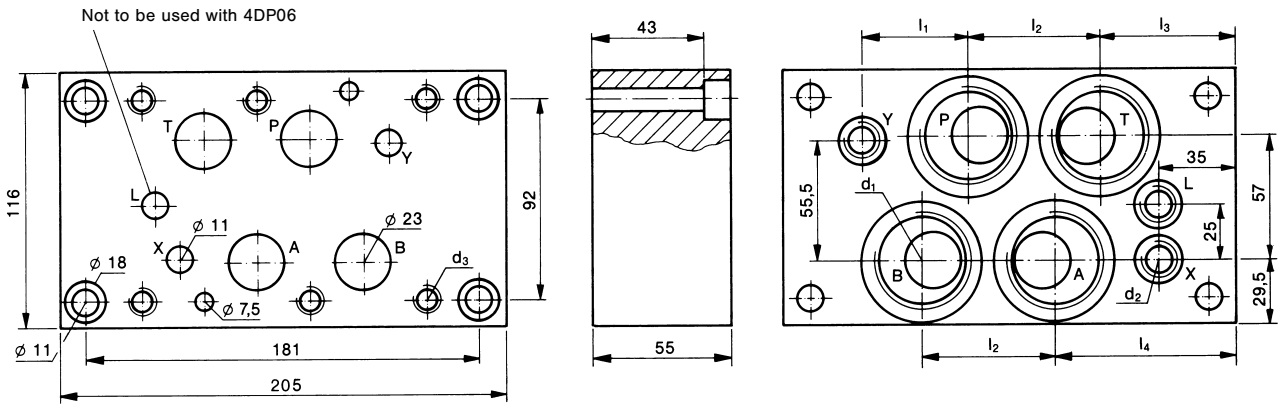

Qty.	Mounting screws	Order-No.
6	M 12 x 65, DIN 912; 10.9	361-12293-8

Please note:

Mounting screws are included in subplate order.

For valves ordered without subplate, mounting screws must be ordered separately.

Torque 103 Nm

Model-No.	Order-No.	d ₁ (A, B, P, T)	d ₂ (X, Y)	d ₃	l ₁	l ₂	l ₃	l ₄
SS-B-12-G 130-L	S26-34487-0	G 3/4"	G 1/4"	M 12	55	49	66	90
SS-B-16-G-130-L	S26-34488-0	G 1"	G 1/4"	M 12	48.5	59.5	62	82

PROPORTIONAL AMPLIFIERS WITH RAMPS

Order No.: 701-00603-8
 one (1) 12 V solenoid
 Order No.: 701-00610-8
 two (2) 12 V solenoids
 Weight: 260 g



These proportional amplifiers are designed to control proportional directional valves without position feedback and 12 V solenoids. They proportionally convert electrical input signals into solenoid current.

The amplifiers have a reverse polarity protection and one (or two) short circuit protected PWM-output stage(s) with max. current limit.

To operate a single solenoid proportional valve with the associated proportional amplifier only the output stage for solenoid A is fitted on the board.

The command signal input will be connected always to the same input line. The different kind of command signals will be set by DIP-switches on the main board. Potentiometers are intended for the adjustment of ramp circuits up/down (independently from each other), max. flow (I_{max}) and min. flow (I_{min}).

The zero-point adjustment enables the positive overlap of the spool, typical of proportional valves, to be bypassed. The electrical zero-point (I_{min}) can be adjusted to 0...50% of I_{max} .

By changing the input signal from 0...2% of max. command signal, the amplifier passes over to the "Imin-leap"-function (dead-band elimination).

There are diagnostic LED's to display the operating condition (POWER ON), ramp function (RAMP ON / OFF) and "FAIL SAFE" in case of short circuit or external STOP of the card. Two test sockets are provided to measure either the actual solenoid current or the command voltage.

Characteristics – Proportional Amplifiers

- Supply voltage
 - nominal
 - smoothed battery voltage
- Reference voltage
- Solenoid nominal current
- Current consumption max.
 - 12 V solenoid
- Short circuit protection
- Input signals

24 V DC
 20...32 V DC
 ± 15 V ($\pm 5\%$) @ 50 mA from amplifier
 ± 10 V ($\pm 0.5\%$) @ 10 mA stabilised from amplifier
 $I_{nom} = 2.2$ A at 100% command signal

< 3 A
 for solenoid

	1 solenoid	2 solenoids	Input impedance
1.	0...+20 mA = 0...+100%	-20...0...+20 mA = -100...0...+100%	100 Ω
2.	+4...+20 mA = 0...+100%	+4...+20 mA = -100...0...+100%	100 Ω
3.	0...+5 V = 0...+100%	-5...0...+5 V = -100...0...+100%	100 k Ω
4.	0...+10 V = 0...+100%	-10...0...+10 V = -100...0...+100%	200 k Ω
5.	customised selectable; R83 = 20 k Ω /V x Vcommand	customised selectable; R83 = 20 k Ω /V x Vcommand	value determined by R83

- Outputs
- External stop (nom 24 V)
- Ramp off (nom 24 V)
- Potentiometer for
 - max. flow (I_{max} A, B)
 - min. flow (I_{min} A, B)
 - ramp up
 - ramp down
- Dither frequency
- Test socket
 - solenoid current
 - command voltage

+ = solenoid A, (- = solenoid B for two solenoid version)
 illuminates on "FAIL SAFE", implement as NC (normally closed circuit) connection with an input voltage of 4 V...32 V; input impedance 3.3 k Ω
 illuminates when "RAMP OFF", implement as NO (normally open circuit) connection with an input voltage of 4 V...32 V; input impedance 3.3 k Ω

...2.2 A
 0...50% of I_{max} ; factory set 0%
 0.2...10 s $\pm 20\%$ (1...50 V/s)
 0.2...10 s $\pm 20\%$ (1...50 V/s)
 selectable by DIP-switch (150 Hz factory set)

1 V \cong 1 A $\pm 5\%$
 approx. 0...10 V at 100% command signal (depends on I_{min} , I_{max} adjustment)

PROPORTIONAL AMPLIFIERS WITH RAMPS

Dimensions Plug-in module 3U/8HP according to IEC 297

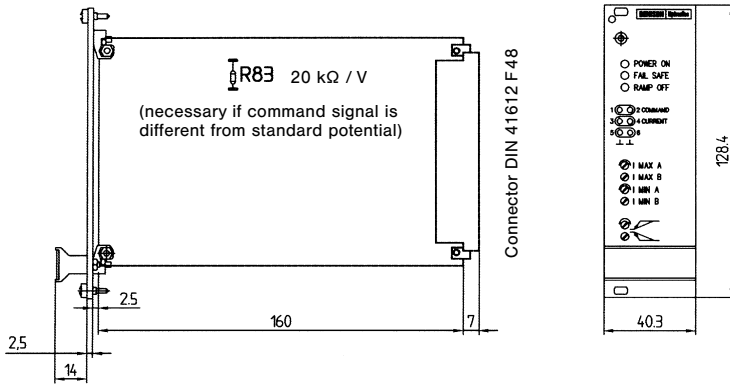

The output stages are short circuit protected. Short circuits at the outputs and supply input voltage falling below 20.5 V will result in the shutdown of the output stages, causing the "Fail Safe" LED come on. In this event, the supply voltage to the proportional amplifier must be switched off for a period of about 10 seconds.

Details on the front panel

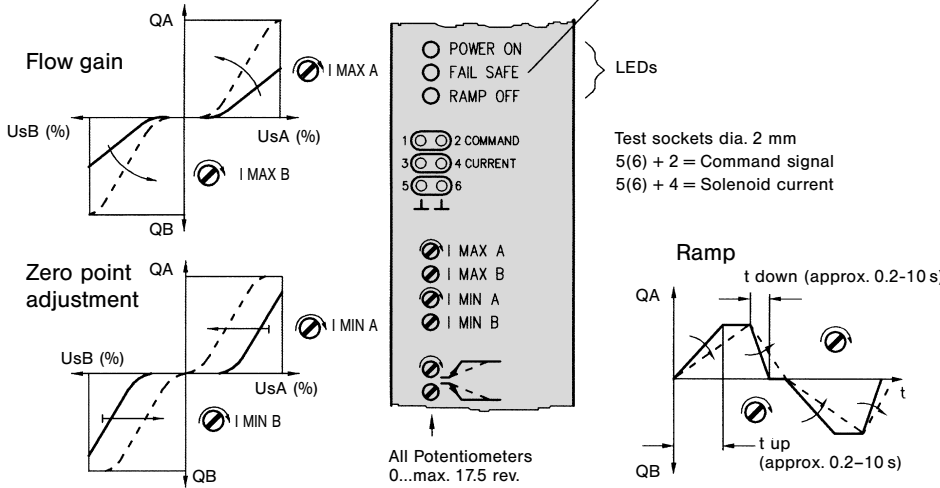

Schematic block diagram and terminal assignment

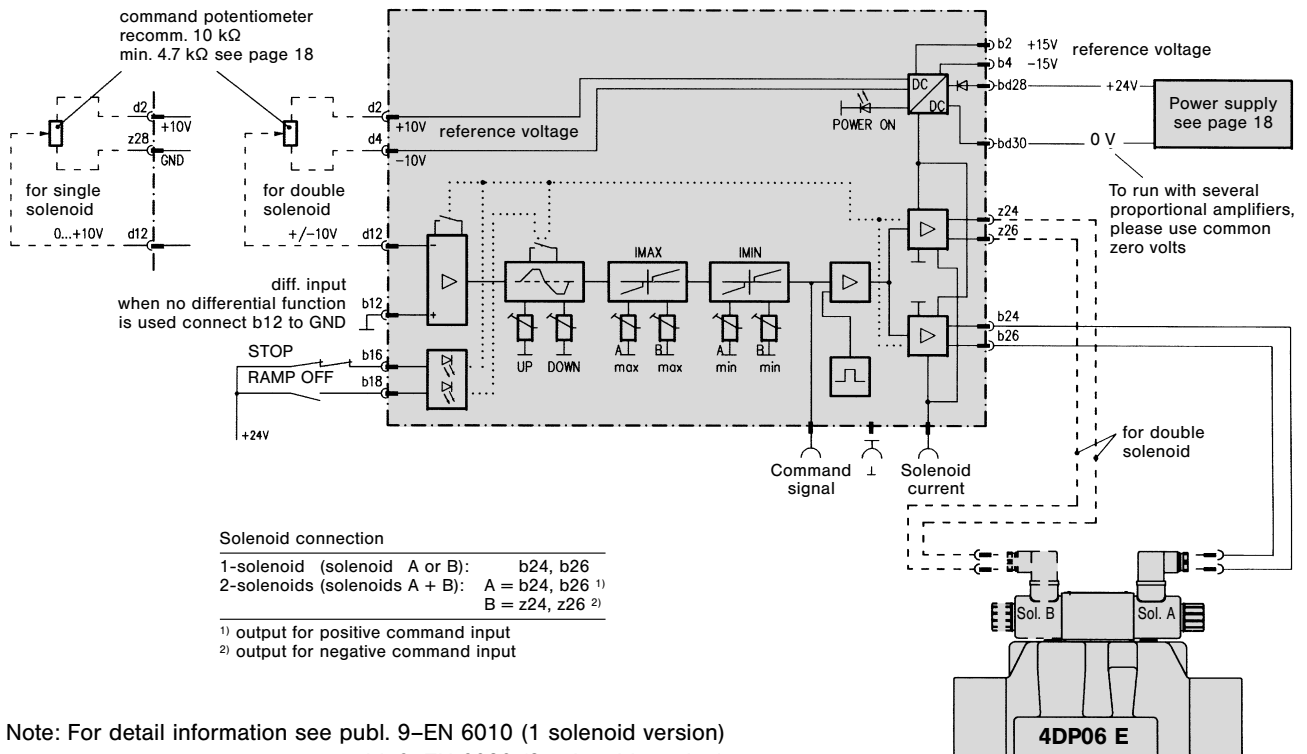

Note: For detail information see publ. 9-EN 6010 (1 solenoid version)
see publ. 9-EN 6020 (2 solenoid version)

COMMAND CARD FIVE CHANNEL

Order No.: 701-00028-8
Weight: 150 g

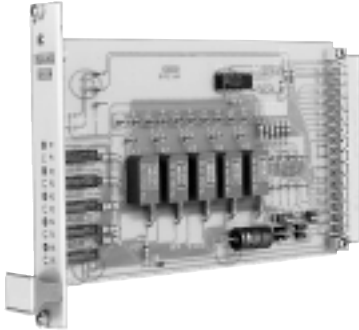

This command card is designed to interface with all proportional amplifiers for DENISON proportional valves.

Five multiturn-potentiometers (P1...P5) allow adjustment of different command signals. Selection is made by external energizing of the five selector relays on the command card.

By moving the soldered bridges (+/-) it is possible to preset positive or negative commands for the desired level and direction.

In addition, the command card has a summing amplifier which enables the monitoring of the internal commands (soldered bridges 1...5), or additional external resistor array.

These inputs (e.g. a 4) also make it possible to cascade further command cards if required.

The output signal to the proportional amplifier is available "not inverted" (a 2) and "inverted" (c 2).

The command card has a power rectifier with a 24 V DC output (input 24 V AC). Via this output c 30/32, the command relays can be energized.

All potentiometers are adjustable on the front panel.

The operating status of the corresponding command is indicated by an LED display on the front pannel (K1...K5).

LED on = Command level selected.

Characteristics – Command Card

- Supply voltage:
 - command card supply from proportional amplifier
 - rectifier 24 V AC (min. 19 V AC)
- Command potentiometer 5 potentiometers 0... 10 V
- Command relays 5 potential – free contacts
- Relay contacts:
 - max. current on contact (resistive load) 100 mA
 - max. switching voltage 30 V
 - coil voltage 24 V DC, approx. 30 mA incl. LED-display

Euro-Card-Holder

Order No. 701-00007-8
Holder for individual mounting according to DIN 41612 design D32

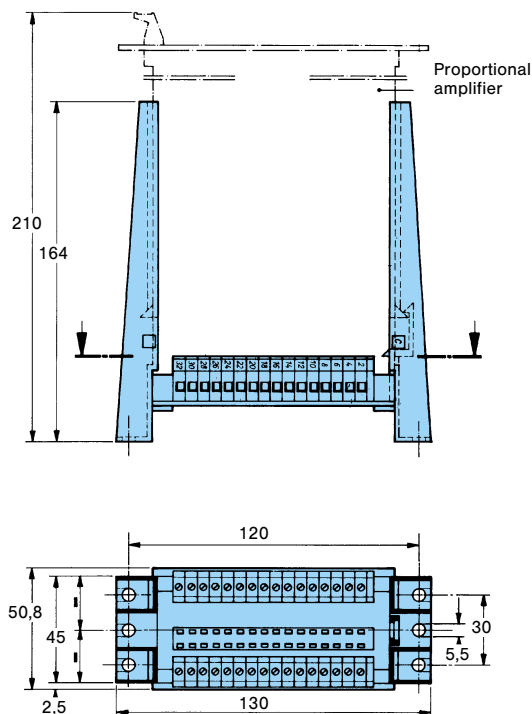

COMMAND CARD FIVE CHANNEL

Dimensions Plug-in module 3U/4HP according to IEC 297

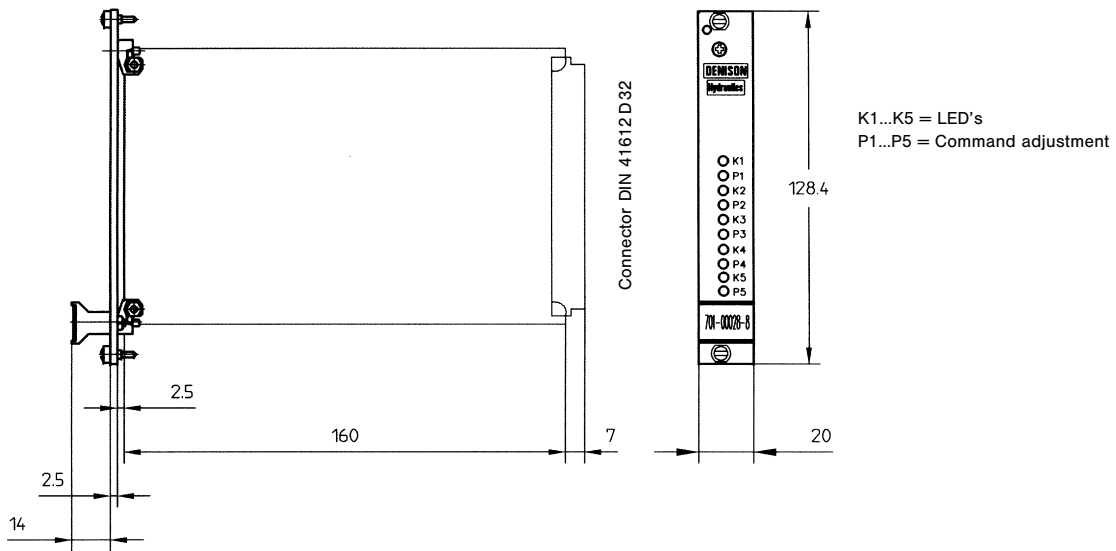

Schematic block diagram and terminal assignment

Proportional amplifier
(see page 15)

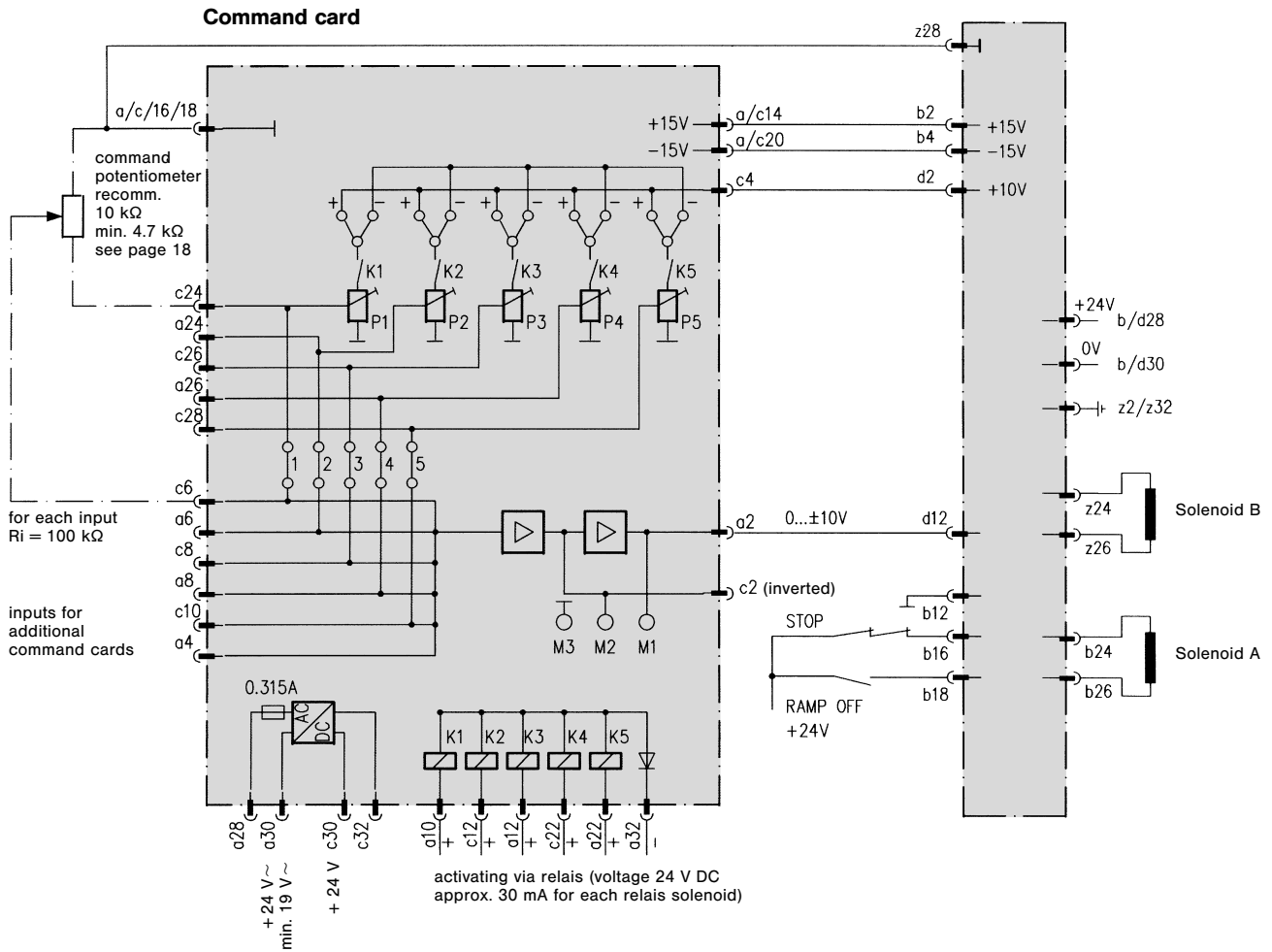

ACCESSORIES

Potentiometer-Adjusting knob Order No. 701-00014-8

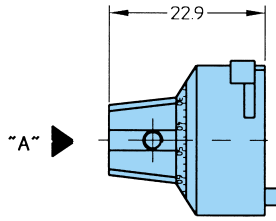
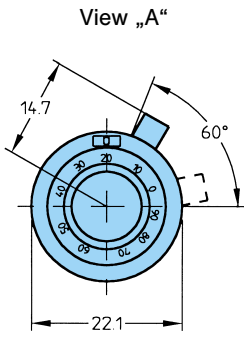

Potentiometer

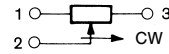
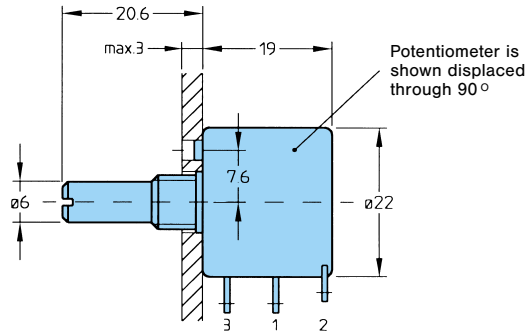

Adjusting knob with scale 0...100 and with revolution counter. Adjustment is lockable.

Panel opening

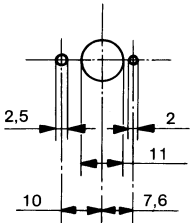

Potentiometer Characteristics	Potentiometer Order No.	
	701-00012-8	701-00013-8
Angle of rotation	360°	3600°
Linearity	± 0.5%	± 0.25%
Resolution-Drift	0.11% of 360°	0.02% of 3600°

Power supply

Order No. 701-00023-8
Weight: 0.25 kg

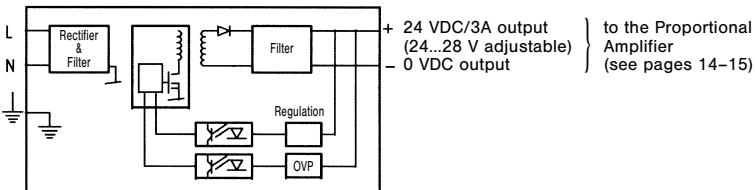
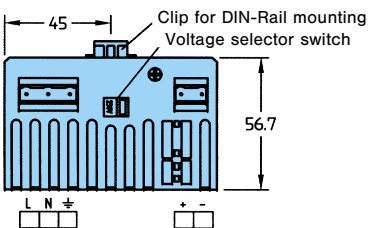
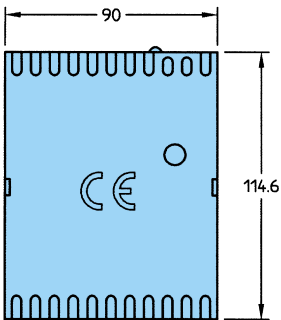

L = Nominal frequency 50/60 Hz
Nominal voltage 230 VAC or 115 VAC (pay attention to voltage selector switch setting)
N = Neutral line

Euro-Card-Holder

Order No. 701-00066-8
Holder for individual mounting according to DIN 41612, design F48

